

FIG. 1

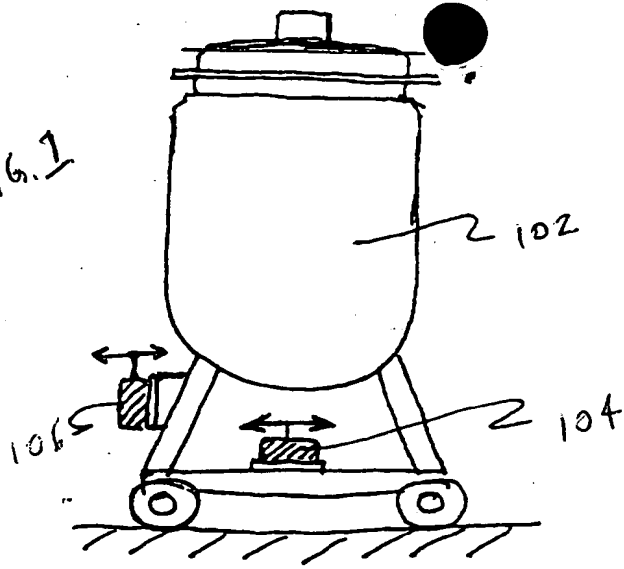

FIG. 2B

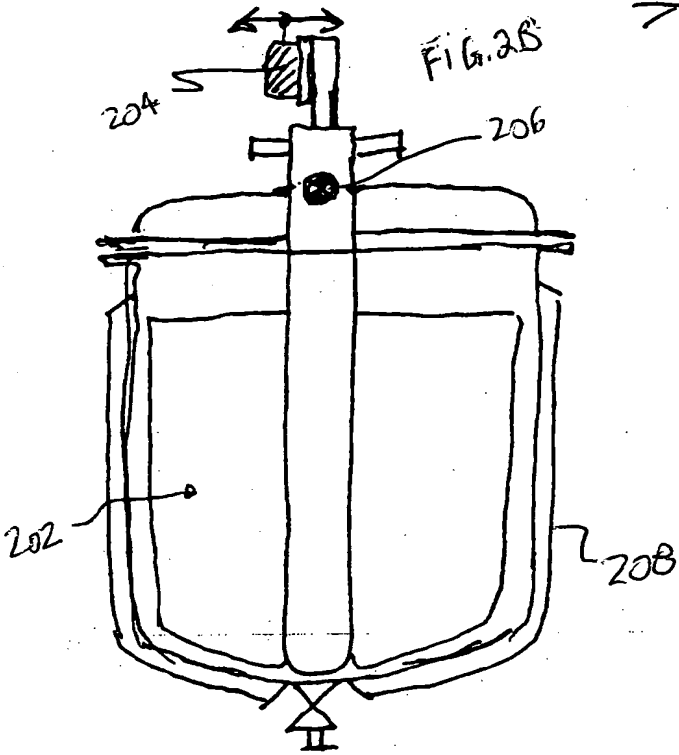

FIG. 2A

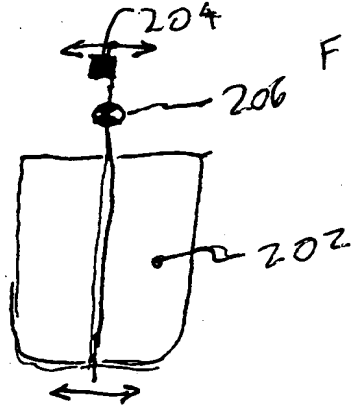
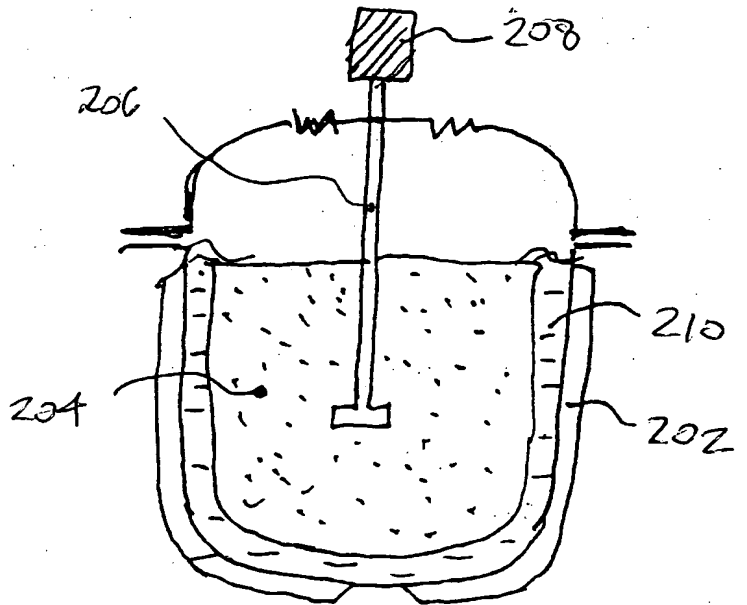

FIG. 3



00950" 5102500

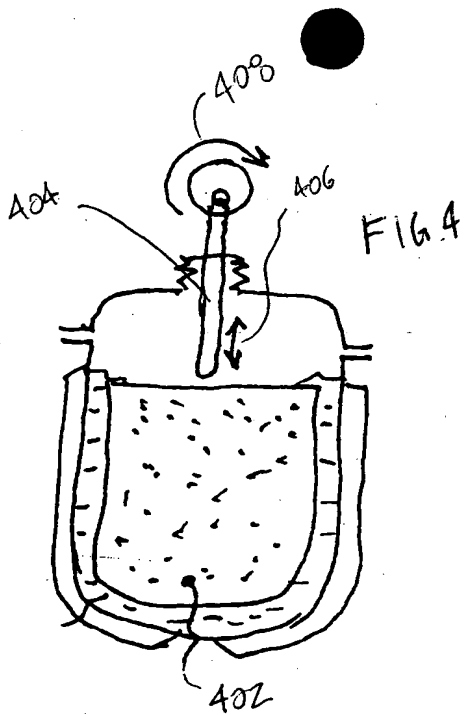

FIG. 5

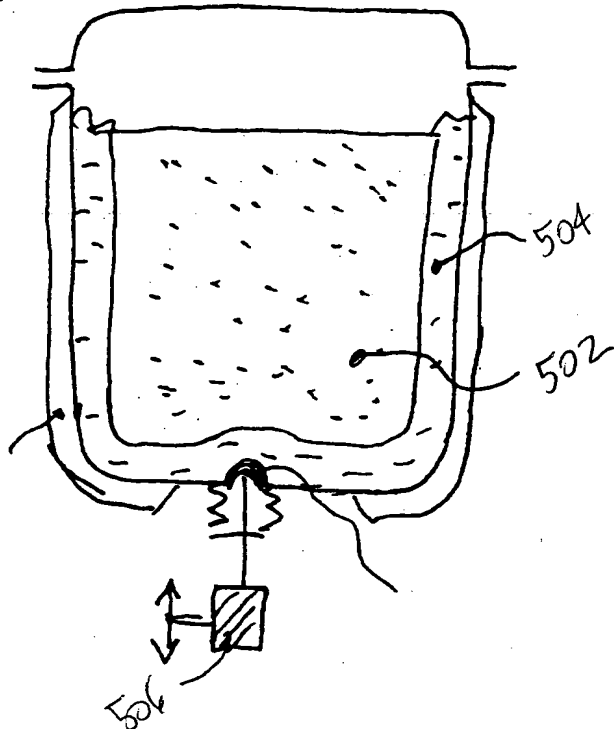

FIG. 6A

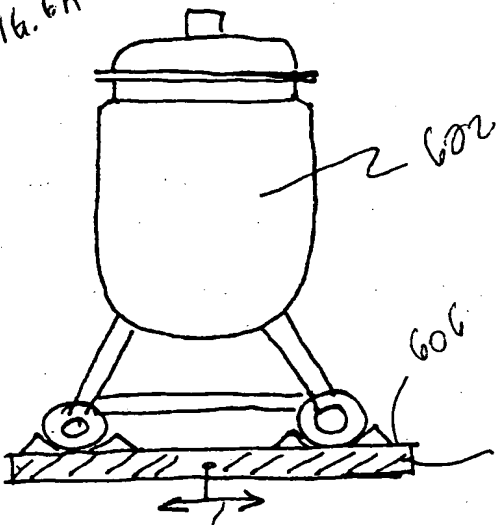

FIG. 6B



FIG. 6C



FIG. 6D



FIG. 7

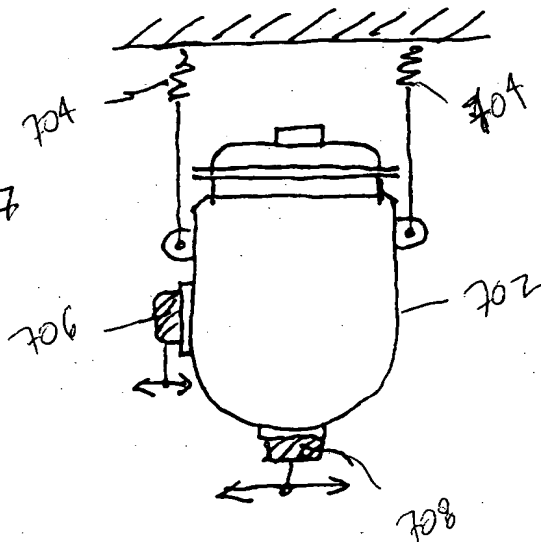

www.patent.com

FIG. 8

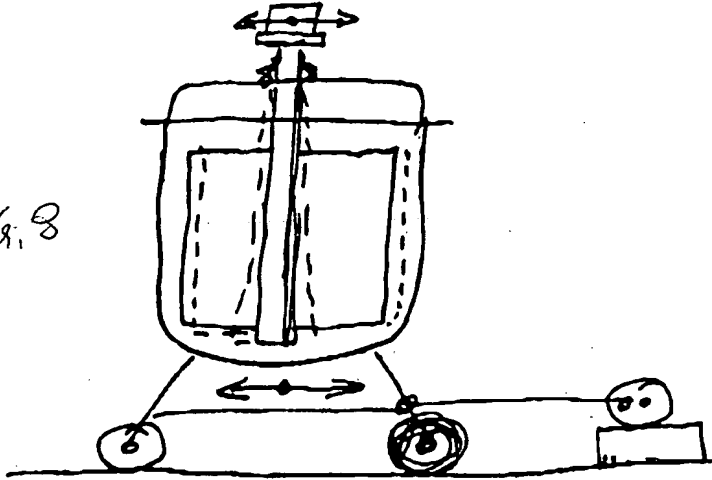

FIG. 9A

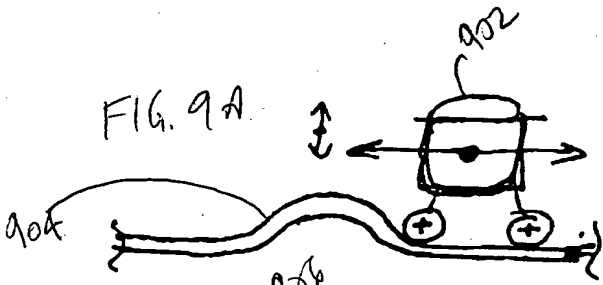

FIG. 9C

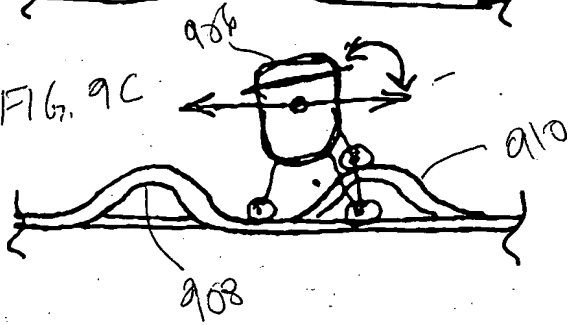

FIG. 9B

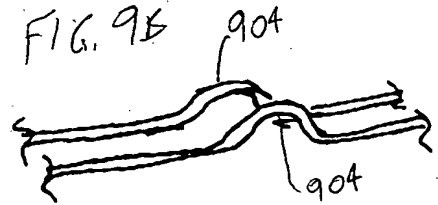

FIG. 9D

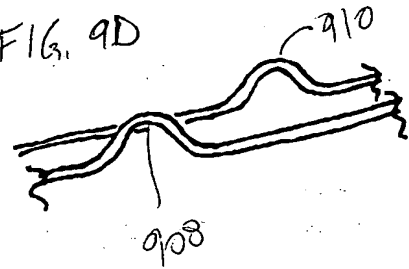

FIG. 10A

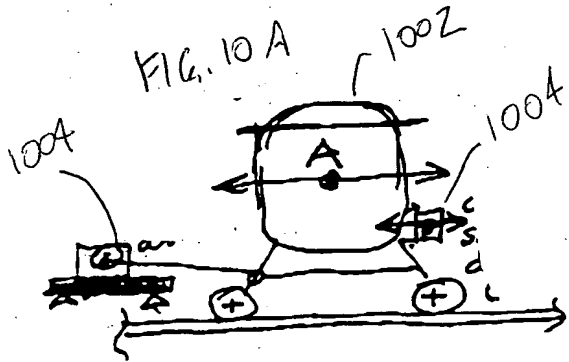

FIG. 10B



00530 316250

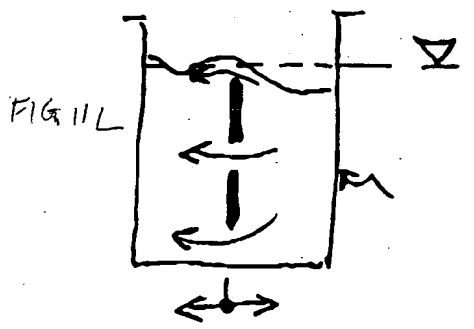
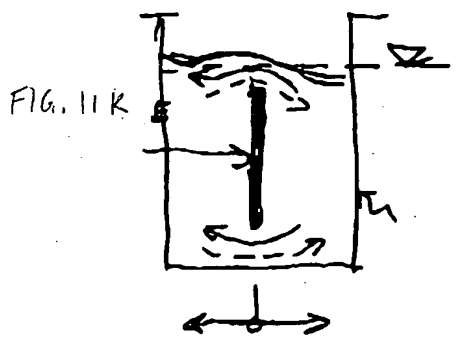
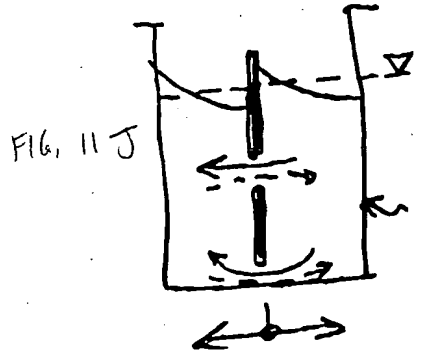
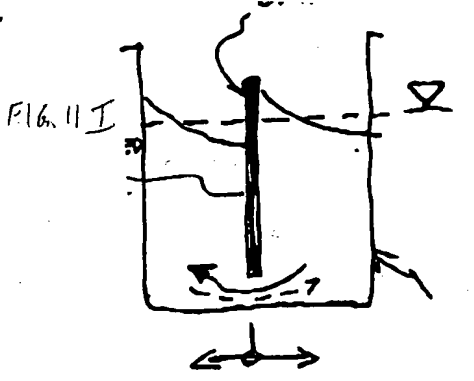
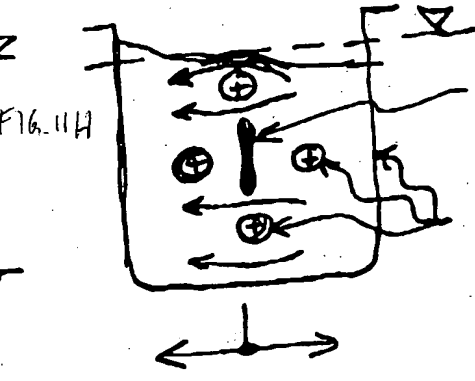
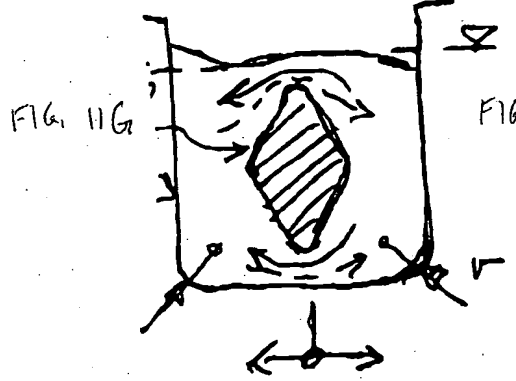
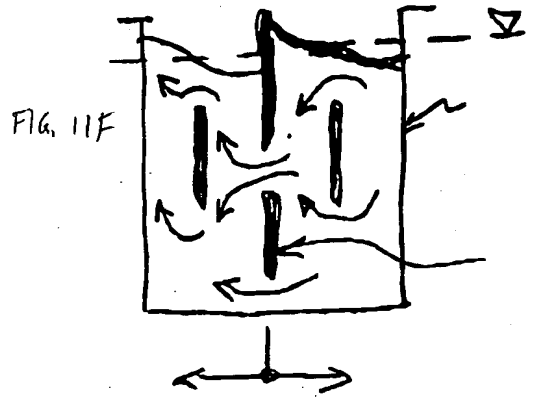
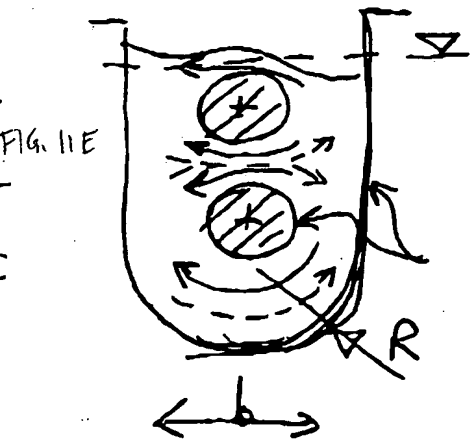
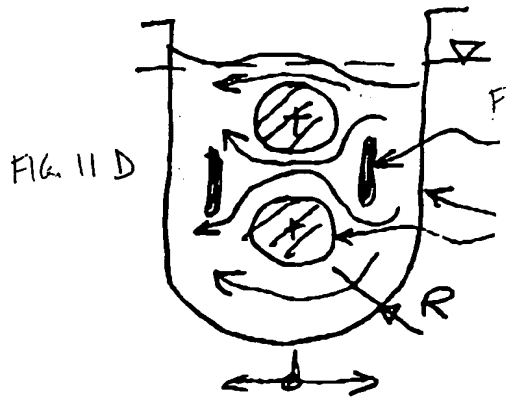
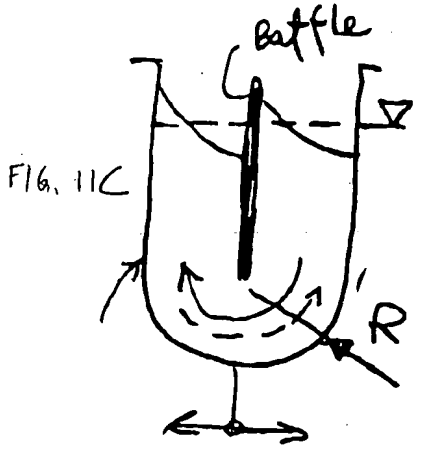
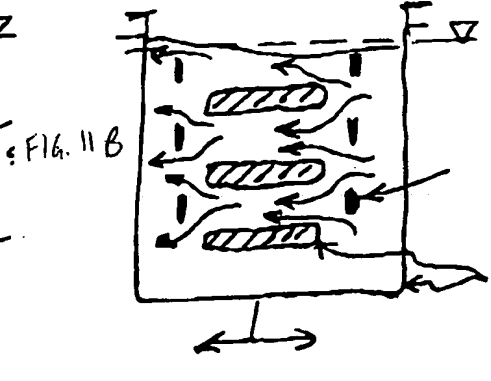
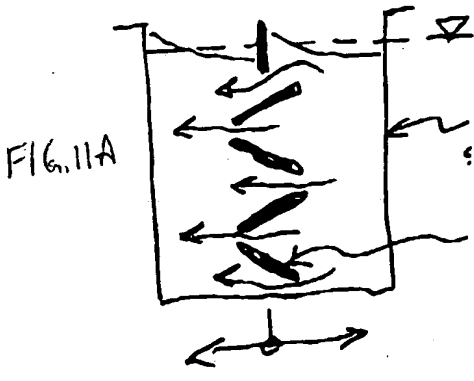

FIG. 12A

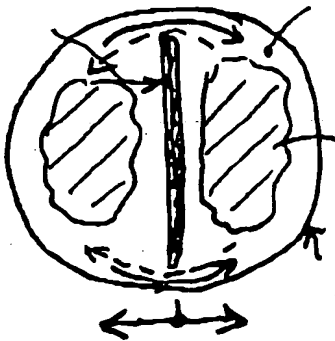

FIG. 12B

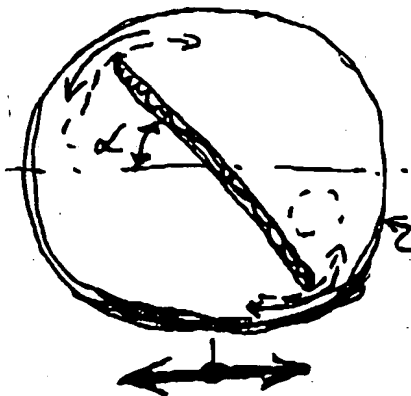

FIG. 12C

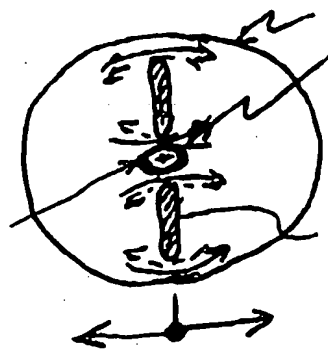

FIG. 12D

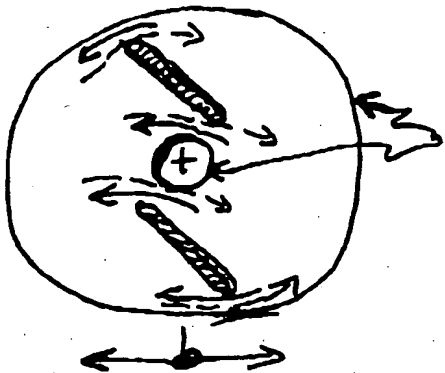

FIG. 12E

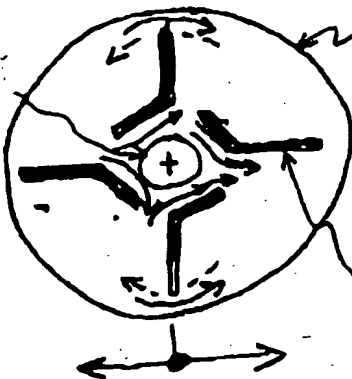

FIG. 12F

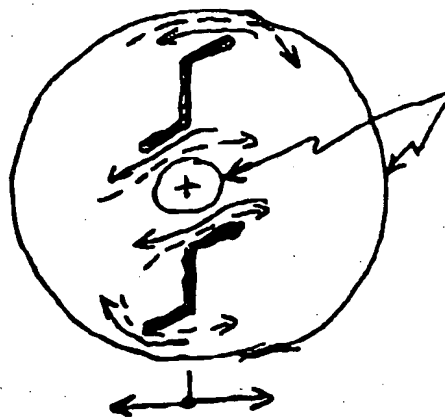

FIG. 12G



FIG. 12H

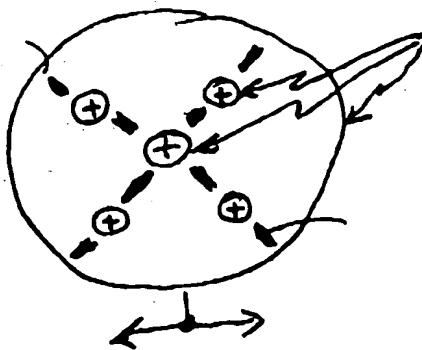
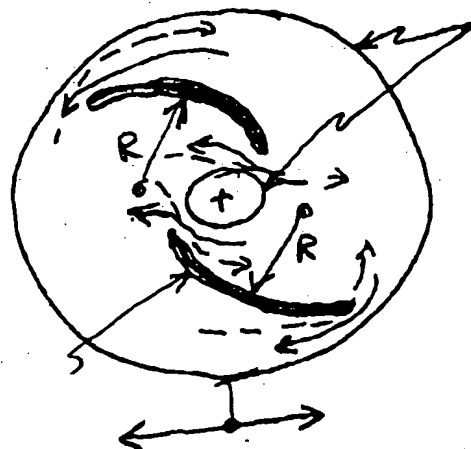

FIG. 12I



655030

FIG. 12 J

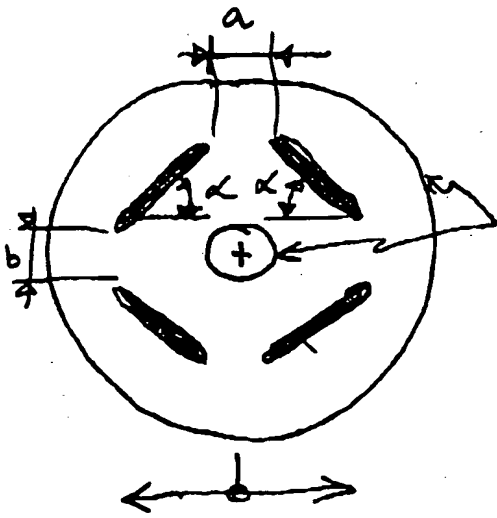

FIG. 12 K

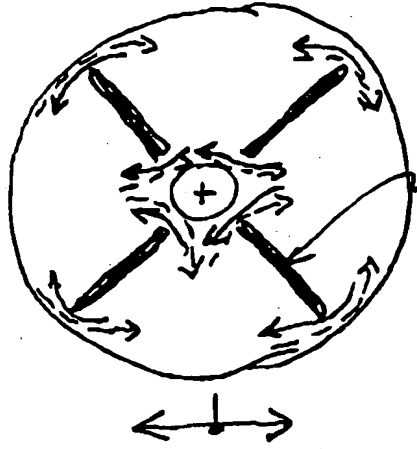

FIG. 12 L

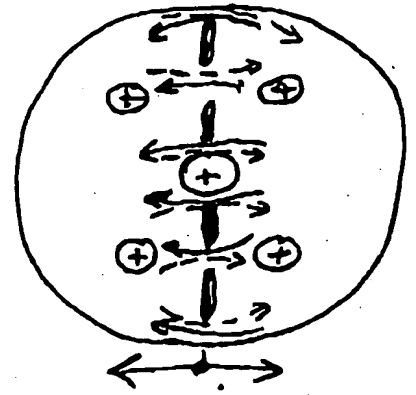

FIG. 12 M

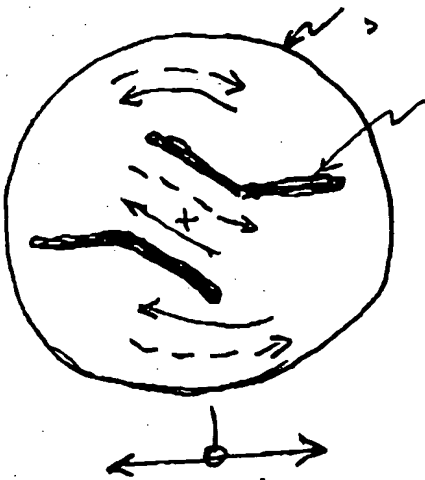

FIG. 12 N

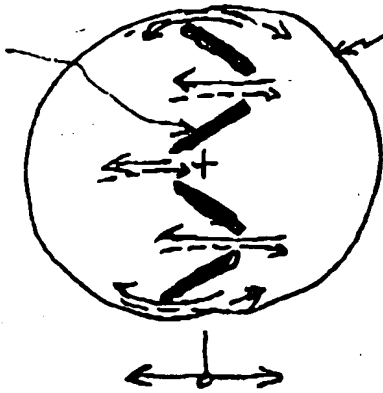

FIG. 12 O

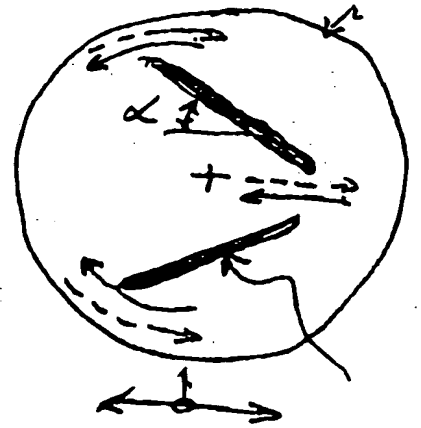
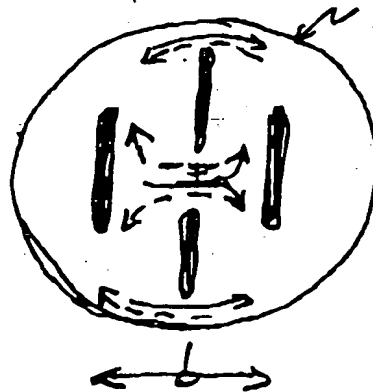

FIG. 12 P



00000 51002000

FIG. 13 A

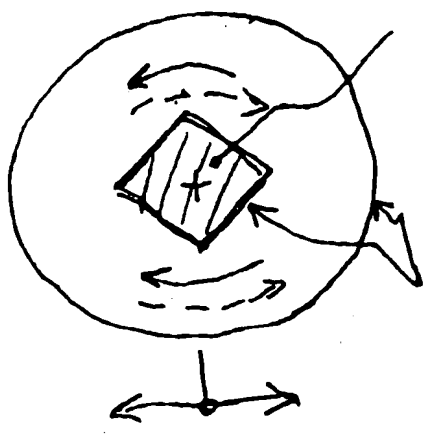

FIG. 13 B

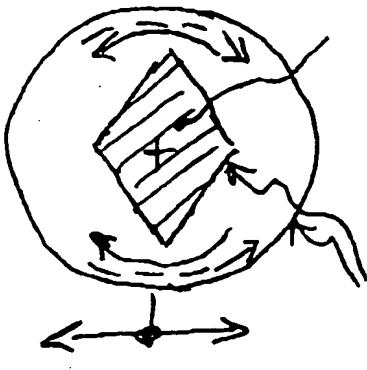

FIG. 13 C

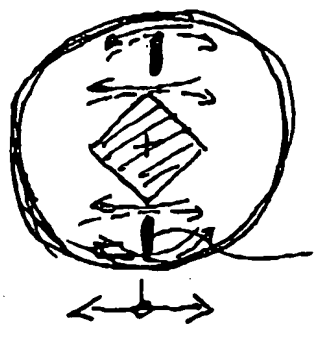

FIG. 13 D

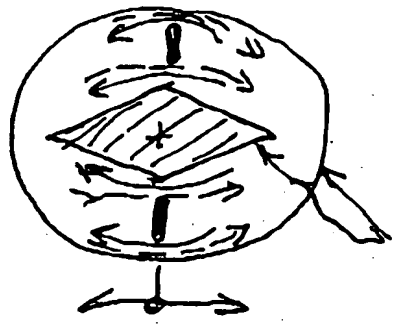

FIG. 13 E

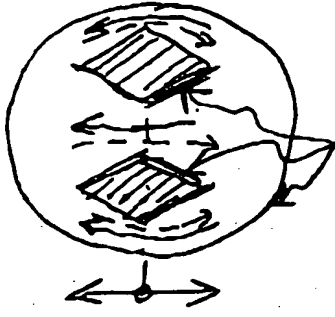

FIG. 13 F

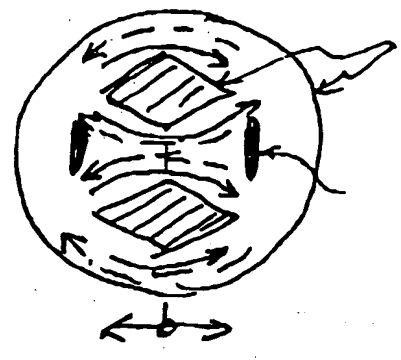

FIG. 13 G

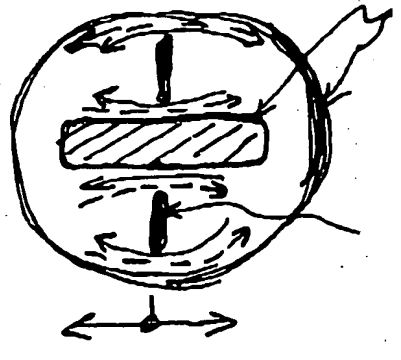

FIG. 13 H



00530" 5102500

FIG. 14 A

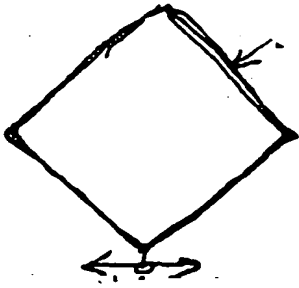

FIG. 14 B

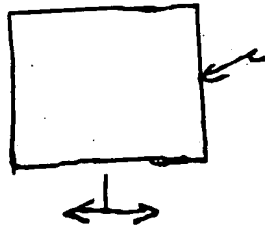

FIG. 14 C

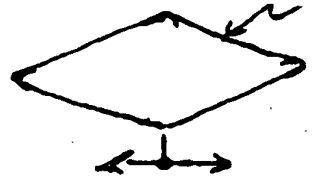

FIG. 14 D

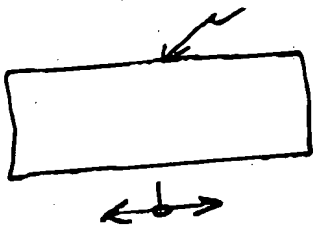

FIG. 14 E

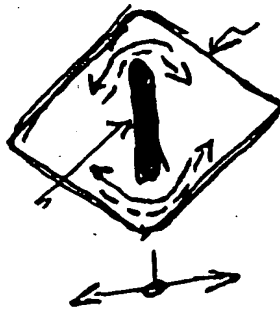

FIG. 14 F

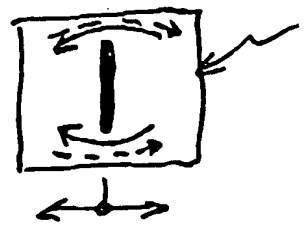

FIG. 14 G



FIG. 14 H



FIG. 14 I

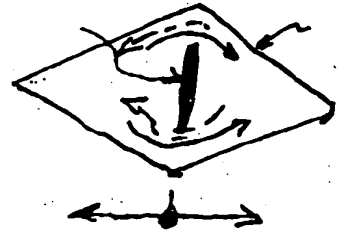

FIG. 14 J

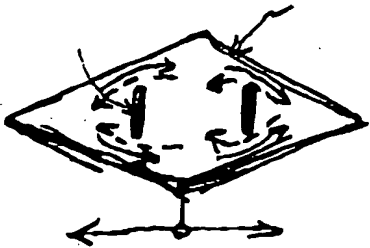

FIG. 14 K

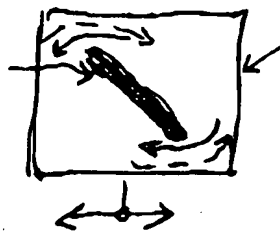

FIG. 14 L



00250 5102500